

Article number: 2030100M20125A1U

Description: E+G levelling foot
GN 30-100-M20-125-A1-U

Note: U Without nut, Hexagon socket at the top, Wrench flat at the bottom

Measures

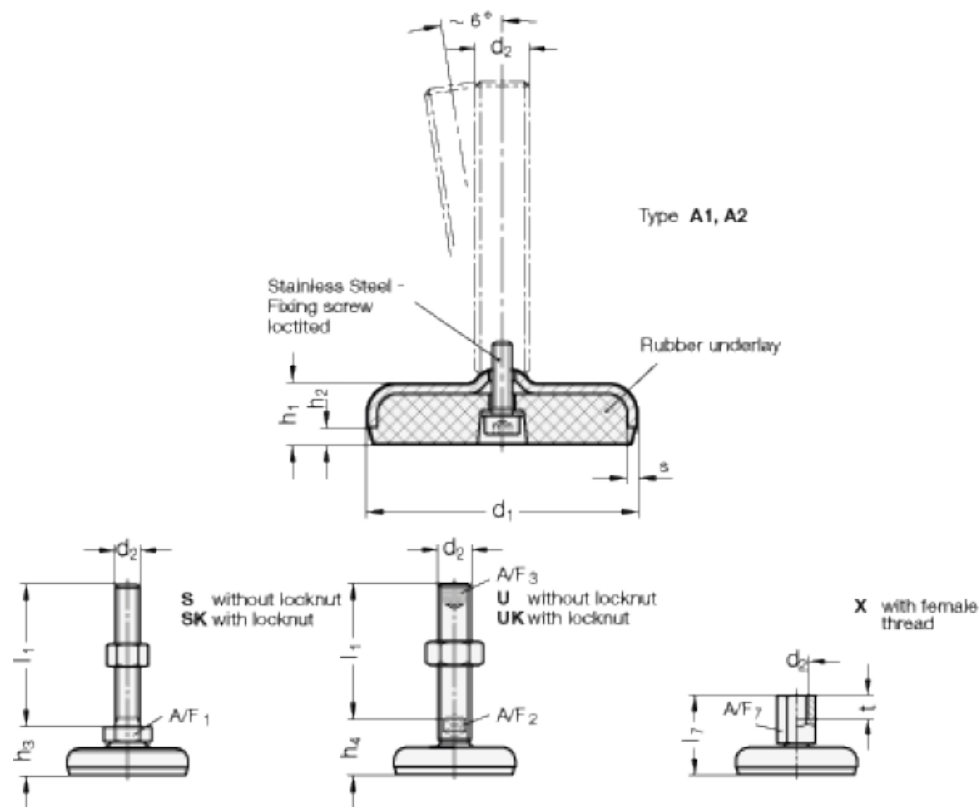

A/F2 = 15

s = 3

A/F3 = 10

d1 = 100

d2 = M20

h1 = 20

h2 = 6

h4 = 35

l1 = 125